

Contact Arrangements

Polbilder

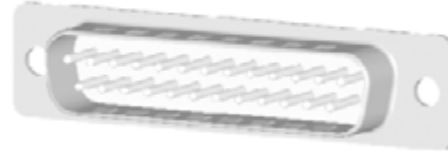

Face view of socket connector
Blick auf Steckseite Buchsensteckverbinder



Face view of pin connector
Blick auf Steckseite Stiftsteckverbinder

Shell Size
Gehäusegröße

Number of Contacts
Polzahl

Pin Connector, Connecting Side
Stiftsteckverbinder, Ansicht steckseitig

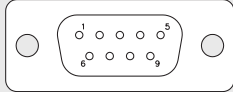
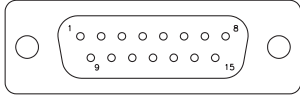
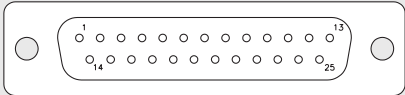
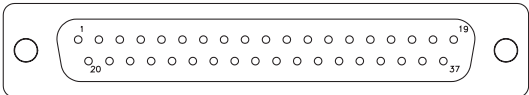
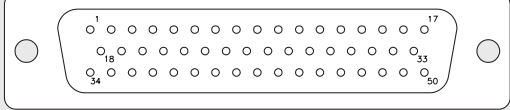
1	9	
2	15	
3	25	
4	37	
5	50	

Standard Connectors

Standard Steckverbinder



Advantages and Special Features

- Connectors for universal application in several of industries (e.g. plant engineering, automation, systems for measurement and control, communication)
- Several material and plating combinations available
- Available in sizes 9-way to 50-way
- Pin/socket contacts, straight, right angled, solder pot, pcb, wire wrap
- Multiple component parts, accessories and modifications available

Vorteile und Merkmale im Überblick

- Steckverbinder für universellen Einsatz in vielen Branchen (z. B. Maschinen- und Anlagenbau, Automatisierungsbranche, Mess-, Steuer- und Regelungstechnik, Kommunikationsbranche etc.)
- Verschiedene Material- und Oberflächenkombinationen verfügbar
- Polzahlen von 9 bis 50 erhältlich
- Pin-/Buchsen Kontakte, gerade, abgewinkelt, Löttopf, PCB, Wire Wrap
- Vielfältige Anbauteile, Zubehör und Modifikationen erhältlich



Shell Dimensions

Gehäuseabmessungen

Pin Connector Shell

Stiftsteckverbindergehäuse

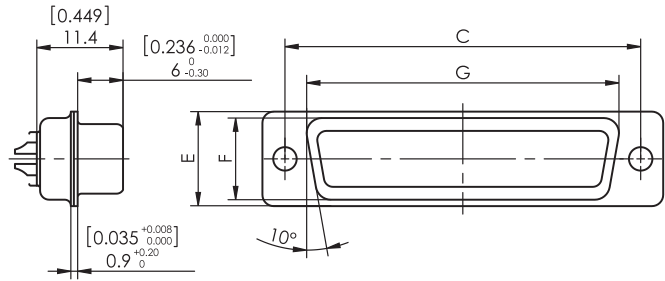
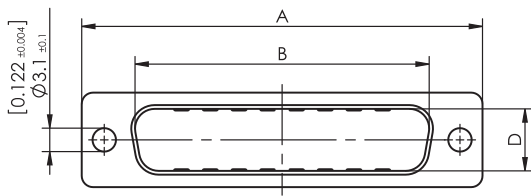

Shell Size Gehäusegröße	No. of Contacts Polzahl	A	B	C	D	E	F	G
		±0,4 (±0.016)	+0,2 (+0.008)	±0,15 (±0.006)	+0,2 (+0.008)	±0,4 (±0.016)	±0,3 (±0.012)	±0,3 (±0.012)
1	9	30,8 (1.213)	16,9 (0.665)	25,0 (0.984)	8,2 (0.323)	12,5 (0.492)	10,8 (0.425)	19,3 (0.760)
2	15	39,1 (1.539)	25,2 (0.992)	33,3 (1.311)	8,2 (0.323)	12,5 (0.492)	10,8 (0.425)	27,5 (1.083)
3	25	53,0 (2.087)	38,9 (1.531)	47,0 (1.852)	8,2 (0.323)	12,5 (0.492)	10,8 (0.425)	41,3 (1.626)
4	37	69,3 (2.728)	55,3 (2.177)	63,5 (2.500)	8,2 (0.323)	12,5 (0.492)	10,8 (0.425)	57,7 (2.272)
5	50	66,9 (2.634)	52,8 (2.079)	61,1 (2.406)	11 (0.433)	15,4 (0.606)	13,7 (0.539)	55,3 (2.177)

Dimensions in mm (inch) - Abmessungen in mm (inch)

Socket Connector Shell

Buchsensteckverbindergehäuse

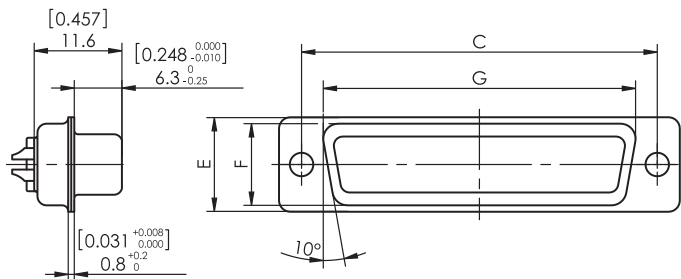
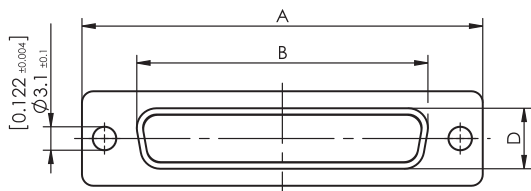

Shell Size Gehäusegröße	No. of Contacts Polzahl	A	B	C	D	E	F	G
		±0,4 (±0.016)	-0,2 (-0.008)	±0,15 (±0.006)	-0,2 (-0.008)	±0,4 (±0.016)	±0,3 (±0.012)	±0,3 (±0.012)
1	9	30,8 (1.213)	16,4 (0.646)	25,0 (0.984)	8 (0.315)	12,5 (0.492)	10,8 (0.425)	19,3 (0.760)
2	15	39,1 (1.539)	24,7 (0.972)	33,3 (1.311)	8 (0.315)	12,5 (0.492)	10,8 (0.425)	27,5 (1.083)
3	25	53,0 (2.087)	38,5 (1.516)	47,0 (1.852)	8 (0.315)	12,5 (0.492)	10,8 (0.425)	41,3 (1.626)
4	37	69,3 (2.728)	54,9 (2.161)	63,5 (2.500)	8 (0.315)	12,5 (0.492)	10,8 (0.425)	57,7 (2.272)
5	50	66,9 (2.634)	52,5 (2.067)	61,1 (2.406)	10,8 (0.425)	15,4 (0.606)	13,7 (0.539)	55,3 (2.177)

Dimensions in mm (inch) - Abmessungen in mm (inch)

Order Code

Bestellschlüssel

UL Recognized File No. 168813

F

W 37 P 0 S G1 A ...

Series Prefix / Serienbezeichnung

Insulator / Isolierkörper

- Standard = Thermoplastic / *Standard = Thermoplast*
- H Heat resistant, please check availability.
Hochtemperaturbeständig, Lieferbarkeit anfragen.
- M Polyester glass fiber filled, zinc plated shell, pin connectors without dimples
Polyester glasfaserverstärkt, Gehäuseoberfläche verzinkt, Stiftsteckverbinder ohne Kontaktnoppen
MIL-C 24308 compliant (not RoHS compliant) / *entsprechend MIL-C 24308 (nicht RoHS konform)*

Mounting Type / Befestigungsarten

- Standard / *Standard*
- W Float mounted, see page 22 / *Schwimmend, siehe Seite 22.*
- T Clinch nut 4-40UNC, see page 412. / *Einnietmutter 4-40 UNC, siehe Seite 412.*
- Z Clinch Nut M3, see page 412. / *Einnietmutter M3, siehe Seite 412.*
- TS Clinch nut 4-40UNC self locking, see page 412. / *Einnietmutter 4-40 UNC selbstsichernd, siehe Seite 412.*
- ZS Clinch nut M3 self locking, see page 412. / *Einnietmutter M3 selbstsichernd, siehe Seite 412.*

No. of Contacts / Polzahl	09	15	25	37	50
Shell Size / Gehäusegröße	1	2	3	4	5

Contact Type / Kontaktart

- P Pin contact / *Stiftkontakt*
- S Socket contact / *Buchsenkontakt*

Contact Design, e.g. / Kontaktvarianten, z.B.

- 0 Solder Pot / *Löttopf*
- 1 Straight PCB Termination / *Leiterplattenanschluss gerade*
- 4 Wire-Wrap / *Wire-Wrap*
- 5 Right angled PCB Termination / *Leiterplattenanschluss abgewinkelt*
- 14 Straight PCB Termination / *Leiterplattenanschluss gerade*
- Machined Contacts
Gedrehte Kontakte
- S Stamped Contacts
Gestanzte Kontakte

For more contacts please see page 24 onwards. *Weitere Kontakte siehe Seite 24ff.*

Direction of Right Angled Contacts

Richtung der abgewinkelten Kontakte

- Standard / *Standard*
- R Reverse (not available with stamped contacts)
Reverse (nicht mit gestanzten Kontakten möglich)

Performance Classes Available in Accordance with Din 41652

Lieferbare Gütestufe nach DIN 41652

G1	= 500 Contact Cycles	= Performance Class 1
	= <i>500 Steckzyklen</i>	= <i>Gütestufe 1</i>
G2	= 200 Contact Cycles	= Performance Class 2
	= <i>200 Steckzyklen</i>	= <i>Gütestufe 2</i>
G3	= 50 Contact Cycles	= Performance Class 3
	= <i>50 Steckzyklen</i>	= <i>Gütestufe 3</i>

Platings for Signal Contacts

Oberflächen für Signalkontakte

- Standard Au over Ni
- *Standard AU über Nickel*
- A AuroPur please see page 20 only in combination with G1 or individual
AuroPur siehe Seite 20 nur in Kombination mit G1 oder individuell

Modifications / Modifikationen



AuroPur High Performance Gold Plating

FCT is introducing a new nickel phosphorous gold plating (min 0,1 μm Au over 2-4 μm chemical NiP) which has better qualities than standard platings. Connectors and contacts with nickel phosphorous gold plating have been tested in accordance with DIN 41626, part 1 and DIN 41652 part 2. A relevant test report is available on request:

Sales Team FCT
sales@fctgroup.com

General Characteristics and Advantages of AuroPur High Performance Gold plating

- High abrasion resistance
- Very good corrosion resistance
- Low thermal contact resistance, very good contact characteristics
- Excellent solderability
- Even plating density
- RoHS compliant
- Non-magnetic on request

Test Construction and Conditions

- Contact resistance in accordance with DIN 41640 part 4 (Start Value / Value after 250 contact durability tests and 21 days corrosive gas)
- Mechanical durability in accordance with DIN 41640 part 21 (250 contact durability tests)
- Industrial atmosphere in accordance with DIN 41640 part 72 (Exposure to flowing mixed gases in accordance with DIN EN 60068-2-60, test Ke, Methode 4)
- Optical testing in accordance with DIN 41640 part 2
- Solderability in accordance with DIN IEC 68 part 2-20
- Micro-impedance measuring device EMT 328
- Corrosion test chamber K350 + TOX gas monitor 7100 (TZO Leipzig)
- Solder bath in accordance with DIN IEC part 2-20

AuroPur Hochleistungs-Goldbeschichtung

FCT führt eine Nickel-Phosphor-Gold Oberfläche (min 0,1 μm Au über 2 - 4 μm chemisches NiP) ein, die im Vergleich zu herkömmlichen Beschichtungen bessere Eigenschaften aufweist. Steckverbinder und Kontakte mit Nickel-Phosphor-Gold Oberfläche sind entsprechend den Anforderungen der DIN 41626, Teil 1 und DIN 41652 Teil 2 getestet. Ein entsprechender Testbericht ist auf Anfrage erhältlich von:

Sales Team FCT
sales@fctgroup.com

Allgemeine Eigenschaften und Vorteile der AuroPur Hochleistungs-Goldbeschichtung

- hohe Abriebsbeständigkeit
- sehr gute Korrosionsbeständigkeit
- niedriger Kontaktwiderstand, sehr gute Kontakteigenschaften
- hervorragende Lötbarkeit
- gleichmäßige Schichtdicke
- RoHS konform
- auf Wunsch non-magnetisch

Testaufbau und -bedingungen

- Durchgangswiderstand nach DIN 41640 Teil 4 (Anfangswert/ Wert nach 250 Steckzyklen und 21 Tagen Schadgas)
- Mechanische Lebensdauer nach DIN 41640 Teil 21 (250 Steckzyklen)
- Industrielatmosphäre nach DIN 41640 Teil 72 (Belastung durch strömendes Mischgas nach DIN EN 60068-2-60, Prüfung Ke, Methode 4)
- Sichtprüfung nach DIN 41640 Teil 2
- Lötbarkeit nach DIN IEC 68 Teil 2-20
- Mikroimpedanzmeßgerät EMT 328
- Korrosionsprüfkammer K350 + TOX GAS Monitor 7100 (TZO Leipzig)
- Lötbad gemäß DIN IEC Teil 2-20

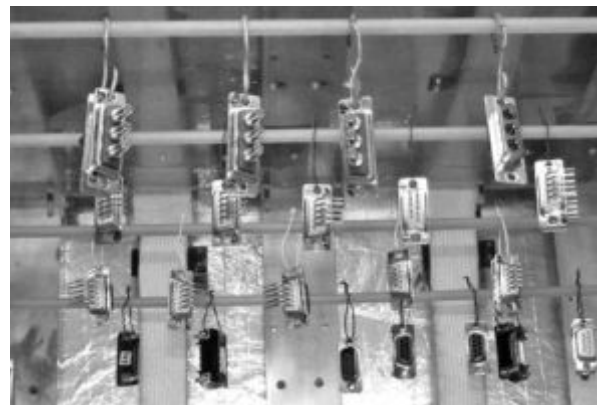

Storage of the test object during the mixed gas exposure
Lagerung der Testobjektes während der Mischgasexposition

Materials and Platings

Materialien und Oberflächen

Shell Gehäuse	Steel Stahl		
Type / Type	F	FH	FM
Insulator Isolierkörper	Polyester, glass fiber filled (UL94V-0), white Polyester, glasfaserverstärkt (UL94V-0), weiß	Polyester, heat resistant, glass filled (UL94V-0), natural Polyester, hochtemperaturbeständig, glasfaserverstärkt (UL94V-0), natur	Polyester, glass fiber filled (UL94V-0), green Polyester, glasfaserverstärkt (UL94V-0), grün
Relative temperature index according to UL 746 B rel. Temperaturindex nach UL 746 B	125 °C (257 °F)	150 °C (302 °F)	130 °C (266 °F)
Heat deflection temperature limit according to DIN 53461 HDT/A Formbeständigkeitstemperatur nach DIN 53461 HDT/A	200 °C (392 °F)	≥255 °C (≥491 °F)	210 °C (410 °F)
Sub temperature limit Untere Grenztemperatur	-55 °C (-67 °F)	-55 °C (-67 °F)	-55 °C (-67 °F)
Shell plating (standard) Gehäuseoberfläche (Standard)	Tin plated over nickel verzinkt über Nickel		Yellow chromate over zinc plating Not RoHS compliant verzinkt und gelb chromatiert nicht RoHS konform
Shell (standard) Gehäuse (Standard)	Pin connector shell with dimples Stiftsteckverbindergehäuse mit Kontaktnoppen		Pin connector shell without dimples Stiftsteckverbindergehäuse ohne Kontaktnoppen
Shell (K120) Gehäuse (K120)			Tin plated over nickel, pin connector shell with dimples verzinkt über Nickel, Stiftsteckverbindergehäuse mit Kontaktnoppen
Shell (K121) Gehäuse (K121)			Tin plated over nickel, pin connector shell without dimples verzinkt über Nickel, Stiftsteckverbindergehäuse ohne Kontaktnoppen
Contact material Kontaktmaterial	Copper alloy Kupfer-Legierung		

Mechanical Data

Mechanische Daten

Mating force per signal contact Steckkraft pro Signalkontakt	≤ 3,4 N
Unmating force per signal contact Ziehkraft pro Signalkontakt	≥ 0,2 N
max. torque * max. Anzugsmoment *	40 Ncm (0,295 ft.lb.) 40 Ncm

* Not for locking screws / * Nicht für Verriegelungsschrauben

Modifications

Modifikationen

All FCT D-Sub connectors (including crimp versions etc.) are available in many different combinations of materials and platings. For example, shells can be supplied in a non – magnetic version made of brass, which can be electroless nickel, or gold plated for use in aerospace technology.
Alle FCT D-Sub Steckverbinder (auch Crimp Versionen, usw.) sind in vielen verschiedenen Material- und Oberflächenkombinationen erhältlich. So z. B. Gehäuse in nichtmagnetischer Ausführung aus Messing bzw. chemisch vernickelte oder vergoldete Gehäuse für Luft- und Raumfahrtanwendungen.

Electrical Data

Elektrische Daten

Current rating at room temperature Maximale Stromstärke bei Raumtemperatur	5 A
Test voltage between 2 contacts / shell and contact Prüfspannung zwischen 2 Kontakten bzw. Kontakt und Gehäuse	1200 V / 1 min.
Meets transition resistance requirements per contact pair in line with DIN 41652: Erfüllt Übergangswiderstand pro Kontaktpaar nach DIN 41652 für:	
_ Straight contacts _ gerade Kontakte	≤ 10 mΩ
_ Right angled contacts _ abgewinkelte Kontakte	≤ 25 mΩ
_ Right angled contacts - 50 way _ abgewinkelte Kontakte bei 50 Polen	≤ 35 mΩ
Insulation resistance between contacts Isolationswiderstand Kontakt / Kontakt	≥ 5000 MΩ
Volume resistivity Spezifischer Durchgangswiderstand	10 ¹⁶ Ω cm
Dielectric strength Spezifische Durchschlagsfestigkeit	50 kV / mm



Mounting Instructions

Panel Cut-Out, Front Mounted

Standard, Front Mounted
Standard, frontseitig montiert

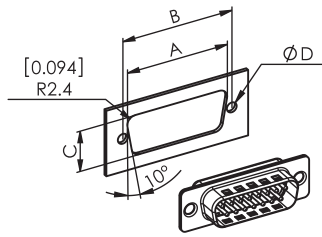

Shell Size	A		B		C	
Gehäusegröße	±0,2	(±0.008)	±0,1	(±0.004)	±0,2	(±0.008)
1	22,2	(0.874)	25,0	(0.984)	12,3	(0.484)
2	30,5	(1.201)	33,3	(1.311)	12,3	(0.484)
3	44,3	(1.744)	47,0	(1.850)	12,3	(0.484)
4	60,7	(2.390)	63,5	(2.500)	12,3	(0.484)
5	58,3	(2.295)	61,1	(2.406)	15,1	(0.594)

Dimensions in mm (inch) - *Abmessungen in mm (inch)*

Montagehinweise

Montageausschnitt, Frontseitig montiert

Float, Front Mounted (Series FW)
Schwimmend, frontseitig montiert (Baureihe FW)

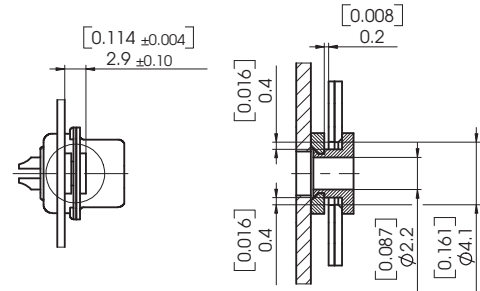

Shell Size	Mounting	Ø D	
Gehäusegröße	Befestigung	±0,05	(±0.002)
1 - 5	Standard Standard	3,1	(0.122)
1 - 5	Float mounted Schwimmend	2,2	(0.087)

Dimensions in mm (inch) - *Abmessungen in mm (inch)*

Rear Mounted

Standard, Rear Mounted
Standard, rückseitig montiert

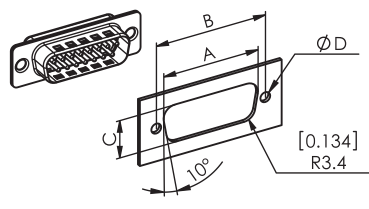

Shell Size	A		B		C	
Gehäusegröße	±0,2	(±0.008)	±0,1	(±0.004)	±0,2	(±0.008)
1	20,5	(0.807)	25,0	(0.984)	11,4	(0.449)
2	28,8	(1.134)	33,3	(1.311)	11,4	(0.449)
3	42,5	(1.673)	47,0	(1.850)	11,4	(0.449)
4	59,1	(2.327)	63,5	(2.500)	11,4	(0.449)
5	56,3	(2.217)	61,1	(2.406)	14,1	(0.555)

Dimensions in mm (inch) - *Abmessungen in mm (inch)*

Rückseitig montiert

Float, Rear Mounted (Series FW)
Schwimmend, rückseitig montiert (Baureihe FW)

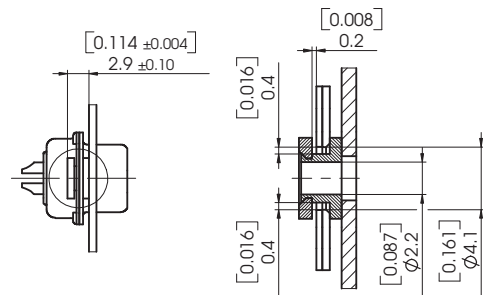

Shell Size	Mounting	Ø D	
Gehäusegröße	Befestigung	±0,05	(±0.002)
1 - 5	Standard Standard	3,1	(0.122)
1 - 5	Float mounted Schwimmend	2,2	(0.087)

Dimensions in mm (inch) - *Abmessungen in mm (inch)*

Mounting and Mating Instructions
Montage- und Steckhinweise

Pulling Range
Fangbereich

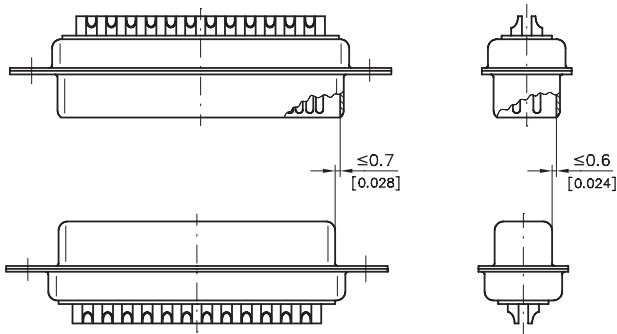

Dimension for Safe Contact Area
Maß für sicheren Kontaktbereich

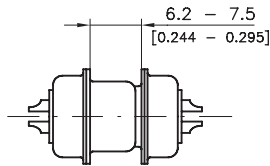

Tilt Angle for Connector Mating
Schräglage zur Steckrichtung

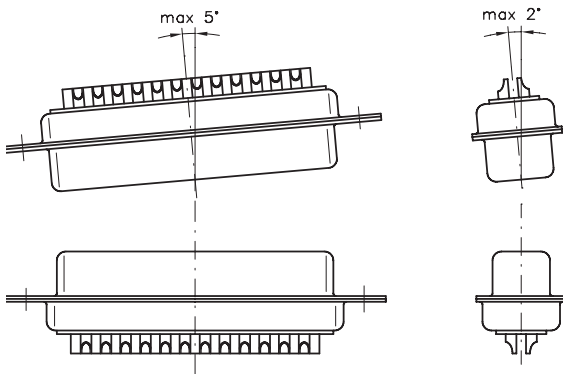

Combinations
Kombinationsmöglichkeiten

Figure <i>Abbildung</i>	Pin <i>Stift</i>	Socket <i>Buchse</i>
1	standard	standard
2	<i>standard</i>	<i>standard</i>
3	standard	Float mounted <i>schwimmend</i>
4	standard	Float mounted <i>schwimmend</i>
5	Float mounted <i>schwimmend</i>	Float mounted
6	Float mounted <i>schwimmend</i>	Float mounted <i>schwimmend</i>

Mounting Combinations
Befestigungsmöglichkeiten

Figure 1
Abbildung 1

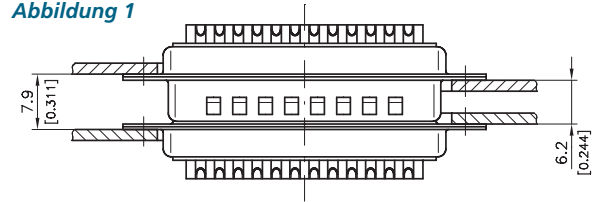

Figure 2
Abbildung 2

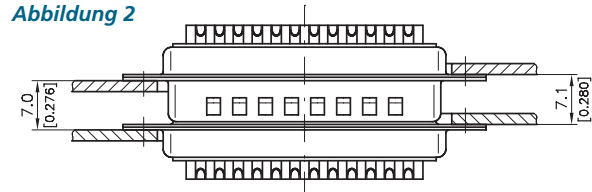

Figure 3
Abbildung 3

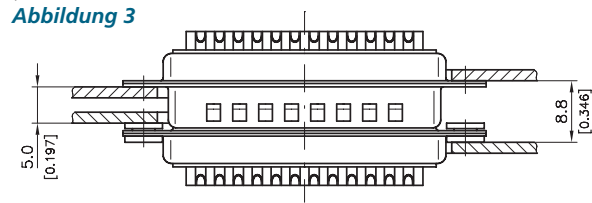

Figure 4
Abbildung 4

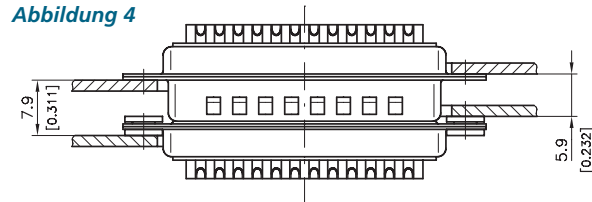

Figure 5
Abbildung 5

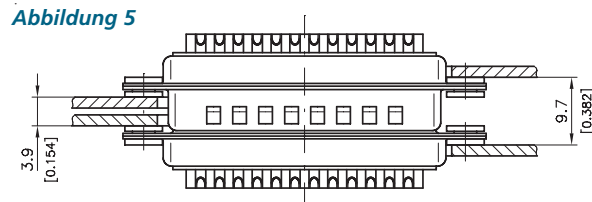
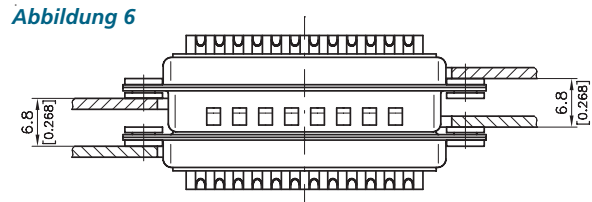

Figure 6
Abbildung 6



Straight Signal Contacts

Gerade Signalkontakte

Solder Pot Termination AWG 20
Löttopfanschluss AWG 20

Straight PCB Termination Ø 0.6 mm (Ø 0.024")
Gerader Leiterplattenanschluss Ø 0,6 mm

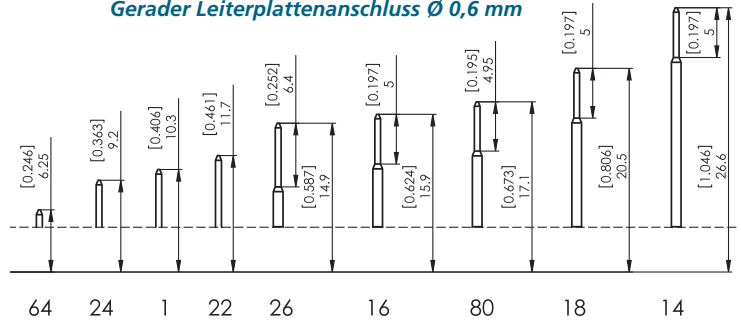
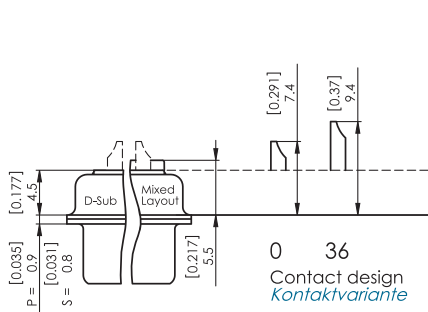

Straight PCB Termination Ø 0.76 mm (Ø 0.030")
Gerader Leiterplattenanschluss Ø 0,76 mm

Wire-Wrap Termination □ 0.6 mm (□ 0.024")
Wire Wrap Anschluss □ 0,6 mm

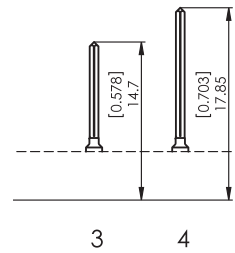
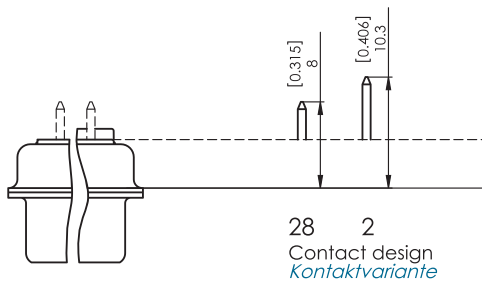

Straight PCB Termination Ø 1.0 mm (Ø 0.039")
Gerader Leiterplattenanschluss Ø 1,0 mm

No Compliant Pressfit Termination □ 0.8 mm (□ 0.031")
Massiver Einpressanschluss □ 0,8 mm

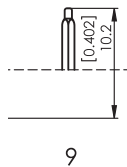
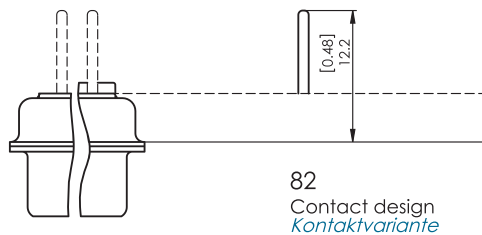

Stamped Contacts with Solder Pot Termination AWG 20
Gestanzter Kontakt mit Löttopfanschluss AWG 20

Line Contact Termination
Kontaktflammenanschluss

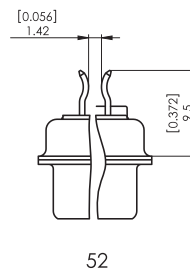
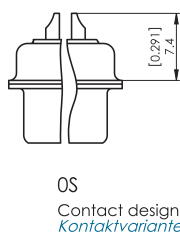

For PCB thickness 1.6 mm (0.063")
Für Leiterplattenstärke 1,6 mm

Right Angled Signal Contacts
 (PCB Termination)

Abgewinkelte Signalkontakte
 (Leiterplattenanschluss)

Spacing 2.54 mm (0.100"), Ø 0.6 mm (Ø 0.024")

Reihenabstand 2,54 mm, Ø 0,6 mm

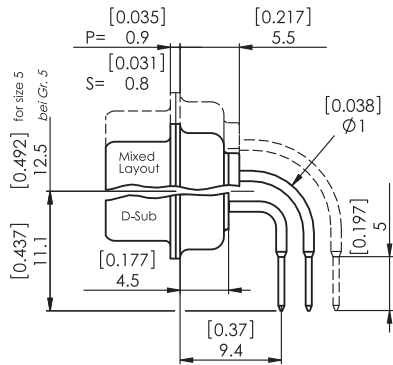

Contact design
 Kontaktvariante 5

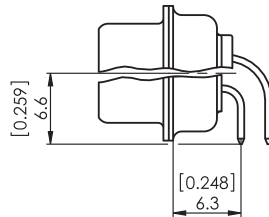

49

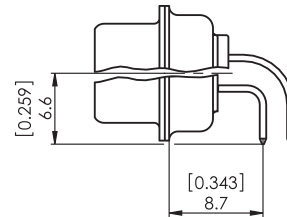

21

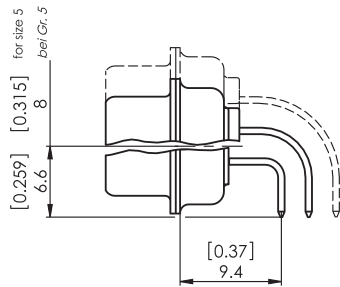

Contact design
 Kontaktvariante 45

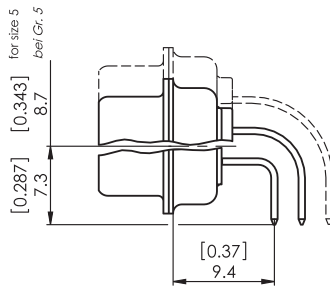

Pin contact on request
 Stiftkontakt auf Anfrage 27

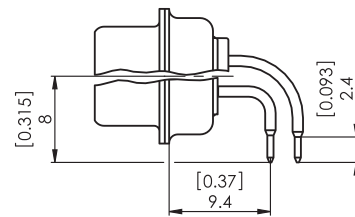

71

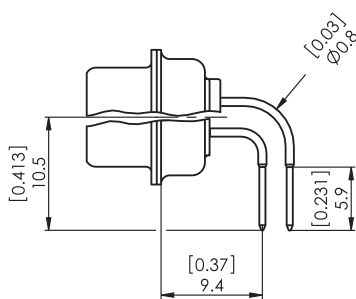

Contact design
 Kontaktvariante 25

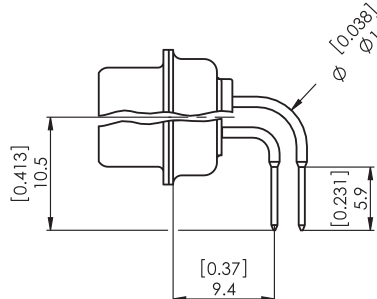

55

Right Angled Signal Contacts
 (PCB Termination)

Spacing 2.54 mm (0.100"), Ø 0.76 mm (Ø 0.030")
 Reihenabstand 2,54 mm, Ø 0,76 mm

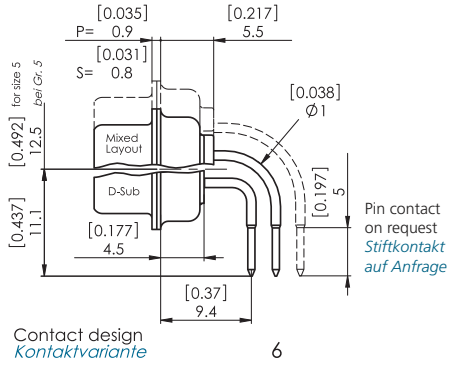

Contact design
 Kontaktvariante

6

Abgewinkelte Signalkontakte
 (Leiterplattenanschluss)

Spacing 2.54 mm (0.100"), Stamped Contact
 Reihenabstand 2,54 mm, gestanzter Kontakt

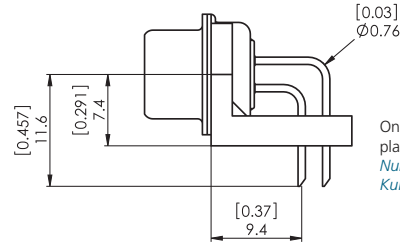

Contact design
 Kontaktvariante

5S

Spacing 2.84 mm (0.112"), Ø 0.6 mm (Ø 0.024")
 Reihenabstand 2,84 mm, Ø 0,6 mm

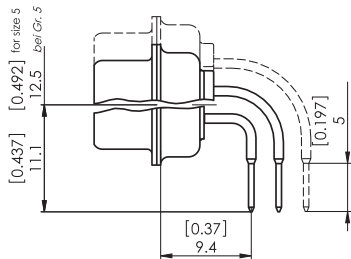

Contact design
 Kontaktvariante

41

Spacing 2.84 mm (0.112"), Ø 0.6 mm (Ø 0.024")
 Reihenabstand 2,84 mm, Ø 0,6 mm

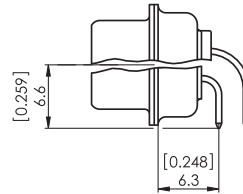

Contact design
 Kontaktvariante

65

Spacing 2.54 mm (0.100"), Ø 0.6 mm (Ø 0.024"), Short Plug
 Reihenabstand 2,54 mm, Ø 0,6 mm, verkürzte Steckseite

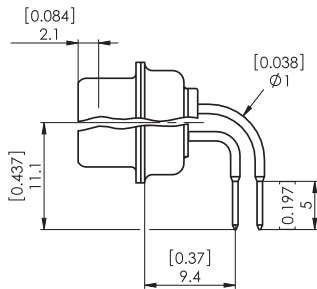

Contact design
 Kontaktvariante

69

Available as a pin contact only.
 Nur als Stiftkontakt verfügbar.

Spacing 2.84 mm (0.112"), Ø 0.76 mm (Ø 0.030")
 Reihenabstand 2,84 mm, Ø 0,76 mm

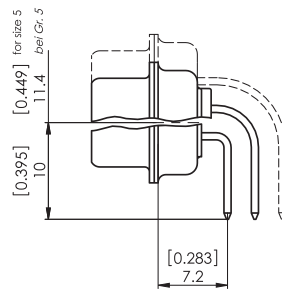

Contact design
 Kontaktvariante

12

Direction of Right Angled
 Signal Contacts

*Richtung der abgewinkelten
 Signalkontakte*

Standard

Standard

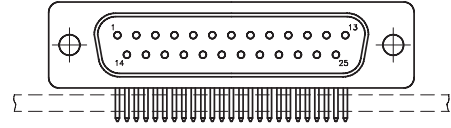
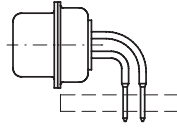
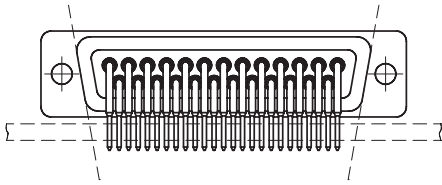

Ordering Example

Pin connector, 25 contacts, right angled PCB termination, spacing 2.54 mm (0.100"), Ø 0.6 mm (Ø 0.024"), performance class 1: **F25P5G1**

Bestellbeispiel

*Stiftsteckverbinder, 25-polig, abgewinkelter Leiterplattenanschluss, 2,54 mm Reihenabstand, Ø 0,6 mm, Gütestufe 1: **F25P5G1***

Revers

Revers

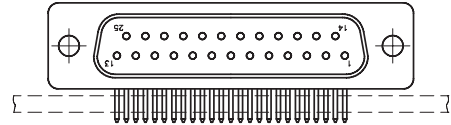
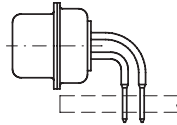
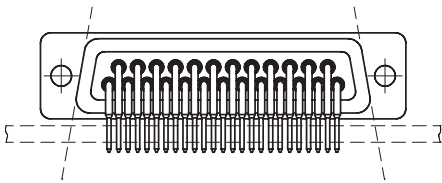

Ordering Example

Pin connector, 25 contacts, right angled PCB termination (reversed), spacing 2.54 mm (0.100"), Ø 0.6 mm (Ø 0.024"), performance class 1: **F25P5RG1**

Bestellbeispiel

*Stiftsteckverbinder, 25-polig, abgewinkelter Leiterplattenanschluss (entgegengesetzt), Reihenabstand 2,54 mm, Ø 0,6 mm, Gütestufe 1: **F25P5RG1***



PCB Hole Patterns According to DIN 41652

Leiterplattenlochbilder nach DIN 41652

9 Contacts

9-polig

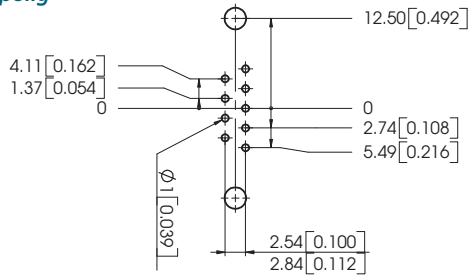

15 Contacts

15-polig

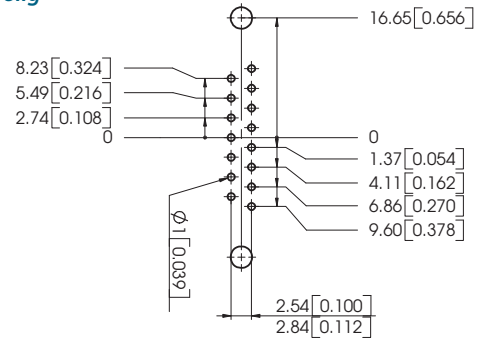

25 Contacts

25-polig

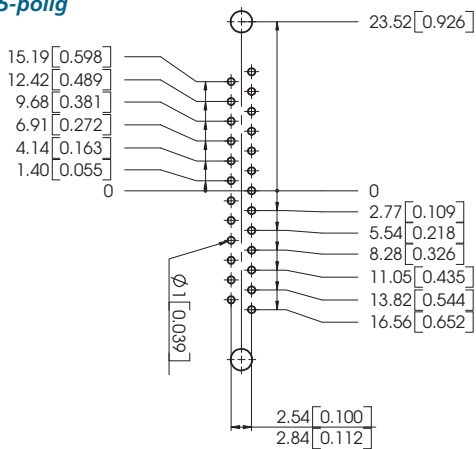

37 Contacts

37-polig

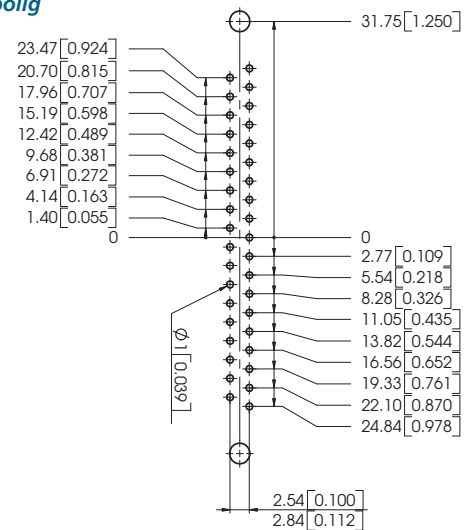

50 Contacts

50-polig

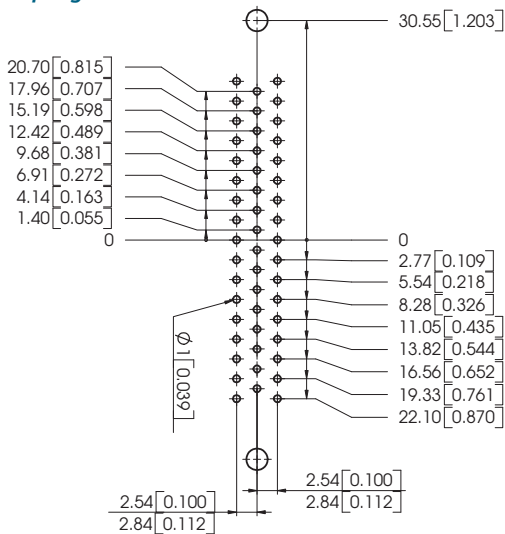

Row Spacing

Reihenabstand

Right Angled Contacts	Straight Contacts
Abgewinkelte Kontakte	Gerade Kontakte

2.54 mm (0.100"), except for contact design, nos. 12, 41 and 69, here: 2.84 mm (0.112")

2,84 mm

2,54 mm, außer bei den Kontaktvarianten 12, 41 und 69, dort: 2,84 mm

(0.112)

For the diameter of assembly drillings, please see assembly parts page 413 onwards.
Für die Durchmesser der Montagebohrungen siehe Anbauteile ab Seite 413.